

SOFFITTO

- Sistema per tende manuale con apertura a strappo
- Larghezza binario: da 70cm a 280cm, giuntabile fino a 840cm
- Profilo in alluminio
- Tappi laterali di chiusura in plastica verniciati in abbinamento al profilo
- Installazione a soffitto tramite supporti girevoli
- Apertura tenda: centrale (cx), laterale sinistra (sx), laterale destra (dx)
- Peso binario: 0.355 kg per metro lineare

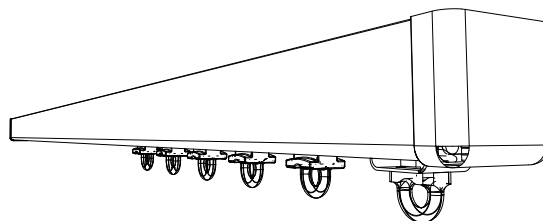

Dettagli binario

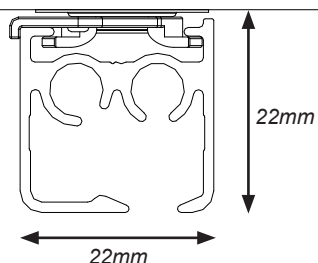

Finiture

*Bianco
RAL 9010



*Nero
RAL 9005



Argento



**Verniciatura opaca.*



Installazione

A soffitto

Supporto

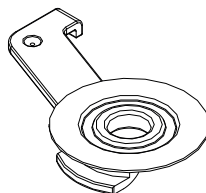
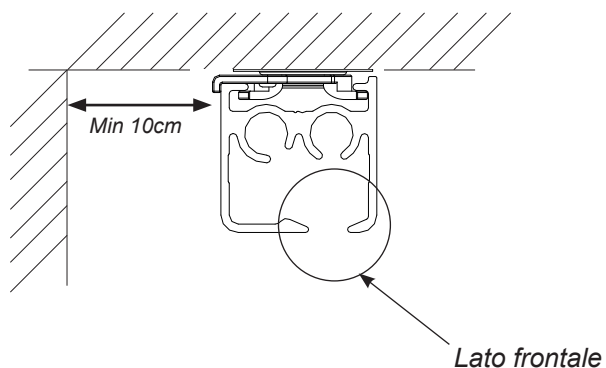

Il sistema viene installato a soffitto con supporti girevoli. La tenda può essere confezionata sotto profilo o a copertura del profilo

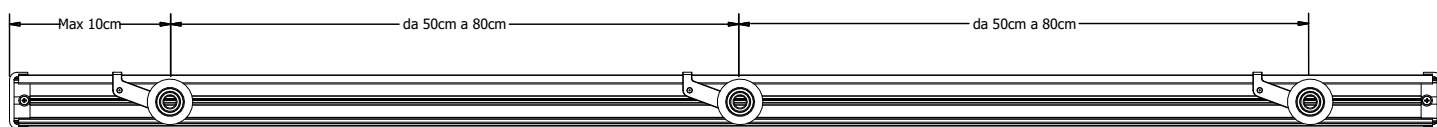

Confezione tende disponibili per installazione a soffitto

ONDULATA

ONDULATA BIFACCIALE

PIEGA PIATTA

PIEGA

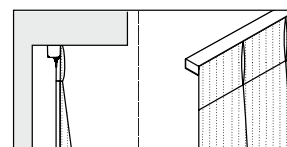
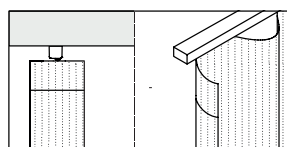
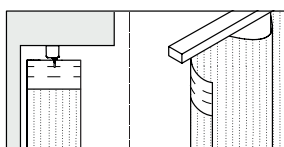

APERTURA

DA DESTRA

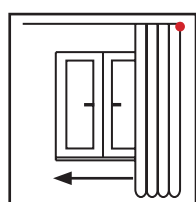

DA SINISTRA

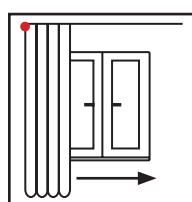

CENTRALE

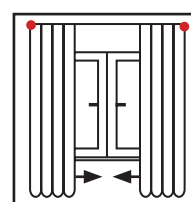

● Fermi per tende



A SOFFITTO PENDINATE

- Sistema per tende pendinate manuali con apertura a strappo
- Larghezza binario: da 70cm a 280cm (sistema giuntabile fino a 840cm)
- Tirante da 12cm a 100cm
- Tiranti a soffitto regolabili fino a 4cm per aggiustamento in posa
- Profilo in alluminio
- Tappi laterali di chiusura in plastica verniciati in abbinamento al profilo
- Installazione a soffitto tramite supporti tiranti
- Apertura tenda: centrale (cx), laterale sinistra (sx), laterale destra (dx)
- Non utilizzabile su confezione a piega piatta

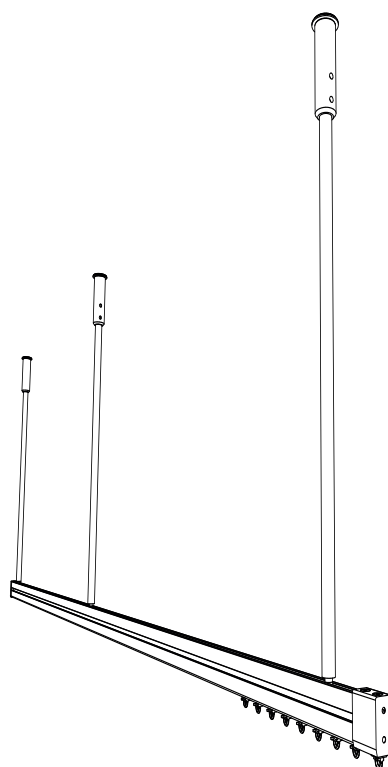

DETTAGLI BINARIO

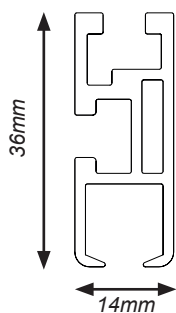

FINITURE

Bianco
RAL 9010



Argento



Verniciatura opaca.



INSTALLAZIONE

A soffitto

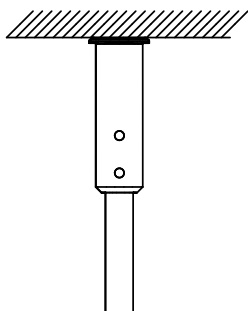

Supporto

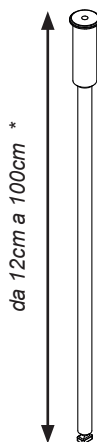

Il sistema viene installato a soffitto tramite tiranti di dimensione minima 12cm e massima 100cm.

*Regolazione fino a 4cm

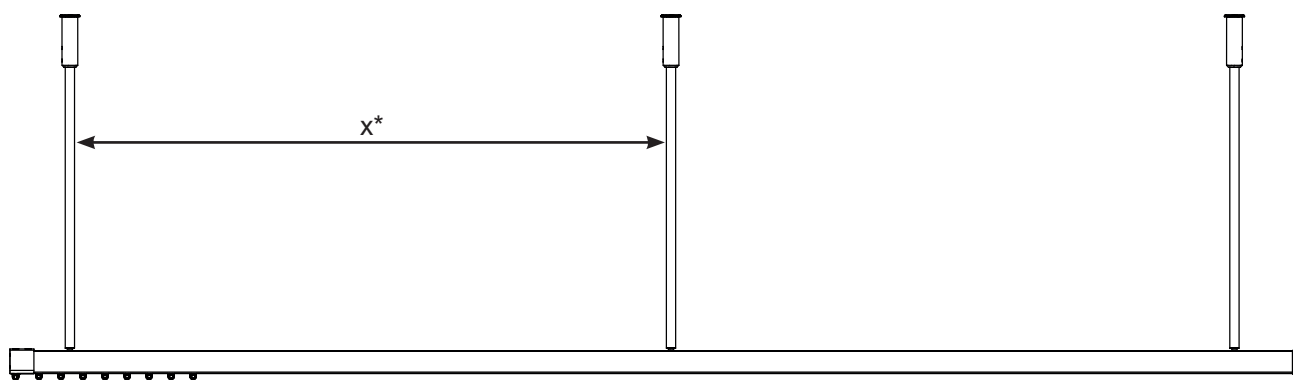

L (cm)	140	210	280	350	420	490	560	630	700	770	840
N.TIRANTI	2	3	3	4	4	5	5	6	6	7	7

*Suddividere la lunghezza del binario in parti uguali in base alla quantità di supporti in dotazione

Confezione tende disponibili per installazione a soffitto

ONDULATA

ONDULATA BIFACCIALE

PIEGA

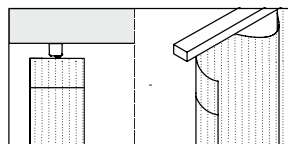
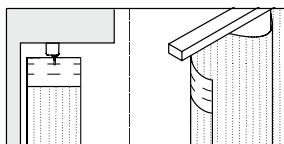

APERTURA

DA DESTRA

DA SINISTRA

CENTRALE

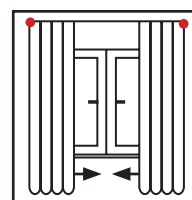
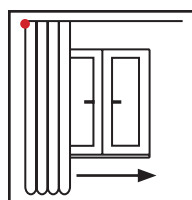
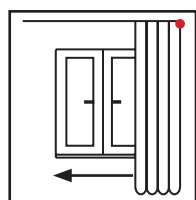



A PARETE

- Larghezza binario: da 70cm a 280cm (sistema giuntabile fino a 840cm)
- Sistema per tende manuali fissate a parete con apertura a strappo
- Profilo in alluminio
- Tappi laterali di chiusura in plastica verniciati in abbinamento al profilo
- Installazione a parete tramite supporti
- Apertura tenda: centrale (cx), laterale sinistro (sx), laterale destro (dx)

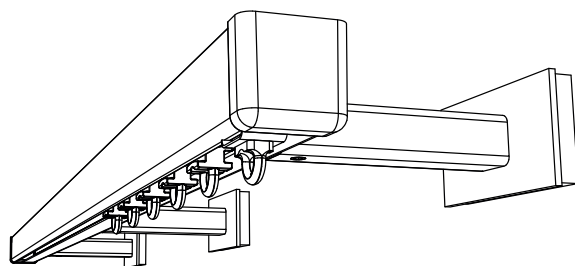

DETTAGLI BINARIO

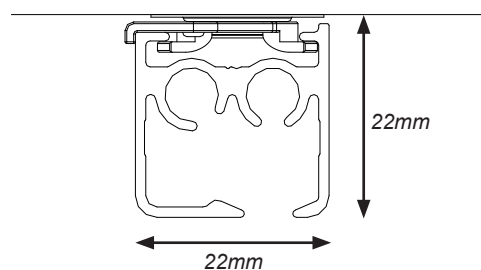
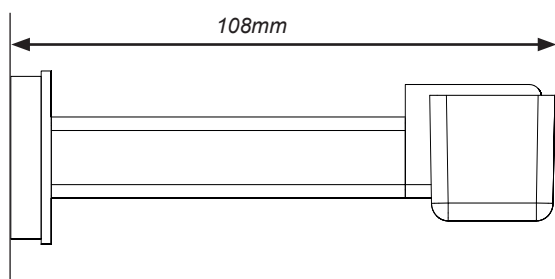

FINITURE

*Bianco
RAL 9010



*Nero
RAL 9005



Argento



**Verniciatura opaca.*



INSTALLAZIONE

a parete

supporto

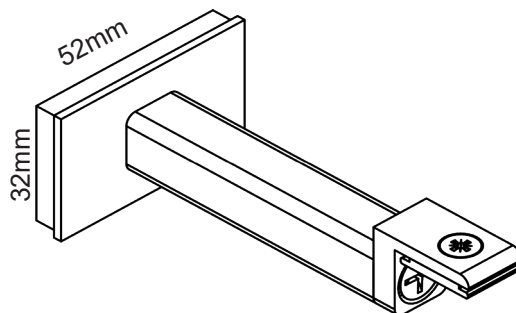
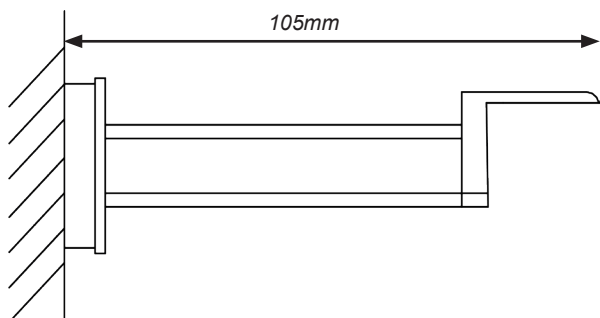

Il sistema viene installato a parete tramite apposite staffe.
La tenda può essere confezionata sotto profilo o a copertura del profilo

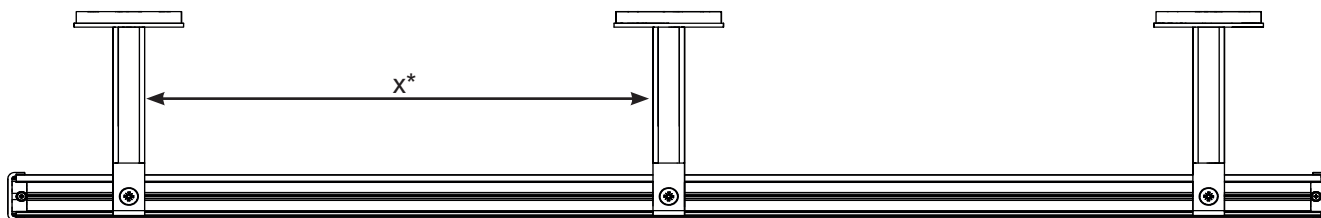

L (cm)	140	210	280	350	420	490	560	630	700	770	840
N.TIRANTI	2	3	3	4	4	5	5	6	6	7	7

*Suddividere la lunghezza del binario in parti uguali in base alla quantità di supporti in dotazione

Confezione tende disponibili per installazione a parete

ONDULATA

ONDULATA BIFACCIALE

PIEGA PIATTA

PIEGA

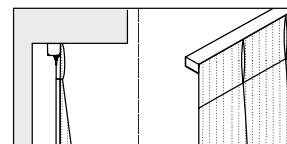
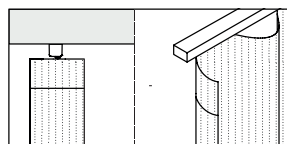
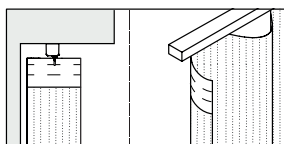

DA DESTRA

DA SINISTRA

CENTRALE

APERTURA

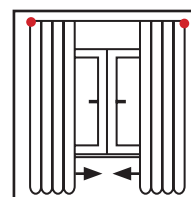
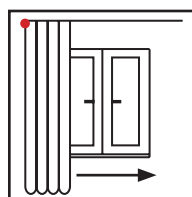
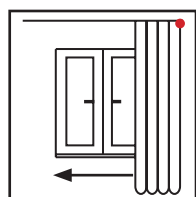



IMPACCHETAMENTO TENDE

Ingombro impacchettamento

Larghezza tenda	140	210	280	350	420	490	560	630	700	770	840
B(cm)	24	36	48	60	72	84	96	108	120	132	144

